

BLL6H0514-25

LDMOS driver transistor

Rev. 04 — 30 March 2010

Product data sheet

1. Product profile

1.1 General description

25 W LDMOS transistor intended for pulsed applications in the 0.5 GHz to 1.4 GHz range.

Table 1. Application information

Typical RF performance at $T_{case} = 25\text{ °C}$; $I_{Dq} = 50\text{ mA}$; in a class-AB application circuit.

Mode of operation	f (MHz)	t _p (μs)	δ (%)	V _{DS} (V)	P _L (W)	G _p (dB)	RL _{in} (dB)	η _D (%)	P _{droop(pulse)} (dB)	t _r (ns)	t _f (ns)
pulsed RF	960 to 1215	128	10	50	25	21	10	58	0.05	8	6
	1200 to 1400	300	10	50	25	19	10	50	0.05	8	6

CAUTION



This device is sensitive to ElectroStatic Discharge (ESD). Therefore care should be taken during transport and handling.

1.2 Features and benefits

- Easy power control
- Integrated ESD protection
- High flexibility with respect to pulse formats
- Excellent ruggedness
- High efficiency
- Excellent thermal stability
- Designed for broadband operation (0.5 GHz to 1.4 GHz)
- Compliant to Directive 2002/95/EC, regarding Restriction of Hazardous Substances (RoHS)

1.3 Applications

- Amplifiers for pulsed applications in the 0.5 GHz to 1.4 GHz frequency range



2. Pinning information

Table 2. Pinning

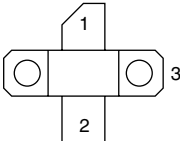
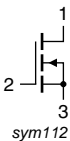
Pin	Description	Simplified outline	Graphic symbol
1	drain		 sym112
2	gate		
3	source		

[1] Connected to flange.

3. Ordering information

Table 3. Ordering information

Type number	Package		
	Name	Description	Version
BLL6H0514-25	-	flanged LDMOST ceramic package; 2 mounting holes; 2 leads	SOT467C

4. Limiting values

Table 4. Limiting values

In accordance with the Absolute Maximum Rating System (IEC 60134).

Symbol	Parameter	Conditions	Min	Max	Unit
V_{DS}	drain-source voltage		-	100	V
V_{GS}	gate-source voltage		-0.5	+13	V
I_D	drain current		-	2.5	A
T_{stg}	storage temperature		-65	+150	°C
T_j	junction temperature		-	200	°C

5. Thermal characteristics

Table 5. Thermal characteristics

Symbol	Parameter	Conditions	Typ	Unit
$Z_{th(j-c)}$	transient thermal impedance from junction to case	$T_{case} = 85\text{ °C}; P_L = 25\text{ W}$		
		$t_p = 100\text{ }\mu\text{s}; \delta = 10\text{ %}$	0.86	K/W
		$t_p = 200\text{ }\mu\text{s}; \delta = 10\text{ %}$	1.11	K/W
		$t_p = 300\text{ }\mu\text{s}; \delta = 10\text{ %}$	1.29	K/W
		$t_p = 100\text{ }\mu\text{s}; \delta = 20\text{ %}$	1.15	K/W

6. Characteristics

Table 6. DC characteristics

$T_j = 25\text{ °C}$; per section unless otherwise specified.

Symbol	Parameter	Conditions	Min	Typ	Max	Unit
$V_{(BR)DSS}$	drain-source breakdown voltage	$V_{GS} = 0\text{ V}$; $I_D = 630\text{ mA}$	110	-	-	V
$V_{GS(th)}$	gate-source threshold voltage	$V_{DS} = 10\text{ V}$; $I_D = 18\text{ mA}$	1.4	1.9	2.4	V
I_{DSS}	drain leakage current	$V_{GS} = 0\text{ V}$; $V_{DS} = 50\text{ V}$	-	-	1	μA
I_{DSX}	drain cut-off current	$V_{GS} = V_{GS(th)} + 3.75\text{ V}$; $V_{DS} = 10\text{ V}$	2.1	2.5	-	A
I_{GSS}	gate leakage current	$V_{GS} = 11\text{ V}$; $V_{DS} = 0\text{ V}$	-	-	100	nA
g_{fs}	forward transconductance	$V_{DS} = 10\text{ V}$; $I_D = 18\text{ mA}$	120	150	-	mS
$R_{DS(on)}$	drain-source on-state resistance	$V_{GS} = V_{GS(th)} + 3.75\text{ V}$; $I_D = 63\text{ mA}$	-	1500	2750	$\text{m}\Omega$

Table 7. RF characteristics

Mode of operation: pulsed RF; $t_p = 128\text{ }\mu\text{s}$; $\delta = 10\%$; RF performance at $V_{DS} = 50\text{ V}$; $I_{DQ} = 50\text{ mA}$; $f = 1.2\text{ GHz}$; $T_{case} = 25\text{ °C}$; unless otherwise specified, in a class-AB production test circuit.

Symbol	Parameter	Conditions	Min	Typ	Max	Unit
P_L	output power		25	-	-	W
V_{DS}	drain-source voltage	$P_L = 25\text{ W}$	-	-	50	V
G_p	power gain	$P_L = 25\text{ W}$	20	21	-	dB
RL_{in}	input return loss	$P_L = 25\text{ W}$	10	15	-	dB
η_D	drain efficiency	$P_L = 25\text{ W}$	57	59	-	%
$P_{\text{droop(pulse)}}$	pulse droop power	$P_L = 25\text{ W}$	-	0	0.3	dB
t_r	rise time	$P_L = 25\text{ W}$	-	20	50	ns
t_f	fall time	$P_L = 25\text{ W}$	-	6	50	ns

6.1 Ruggedness in class-AB operation

The BLL6H0514-25 is capable of withstanding a load mismatch corresponding to $V_{SWR} = 10 : 1$ through all phases under the following conditions: $V_{DS} = 50\text{ V}$; $I_{DQ} = 50\text{ mA}$; $P_L = 25\text{ W}$; $f = 1.2\text{ GHz}$; $t_p = 128\text{ }\mu\text{s}$; $\delta = 10\%$.

7. Application information

7.1 Impedance information

Table 8. Typical impedance

Typical values per section unless otherwise specified.

f MHz	Z _S Ω	Z _L Ω
950	2.37 + j3.3	6.11 + j11.1
1000	2.44 + j2.65	7.00 + j16.0
1050	2.34 + j2.67	7.39 + j14.2
1100	2.56 + j2.06	7.0 + j16.0
1150	2.54 + j1.70	5.77 + j13.85
1200	2.25 + j1.29	7.39 + j14.2
1300	2.21 + j0.15	6.11 + j11.1
1400	2.46 – j0.52	5.00 + j10.0

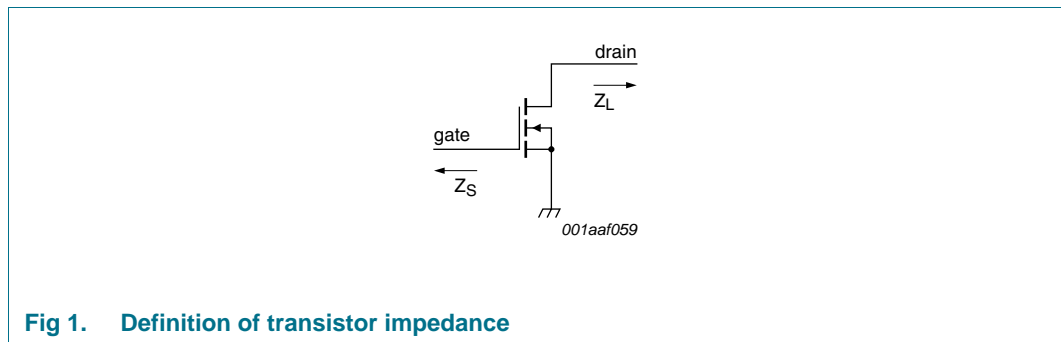

Fig 1. Definition of transistor impedance

7.2 Typical data

Table 9. Application information

Typical RF performance at $T_{case} = 25\text{ °C}$; $I_{DQ} = 50\text{ mA}$; in a class-AB application circuit.

Mode of operation	f (MHz)	t _p (μs)	δ (%)	V _{DS} (V)	P _L (W)	G _p (dB)	RL _{in} (dB)	η _D (%)	P _{droop(pulse)} (dB)	t _r (ns)	t _f (ns)
pulsed RF	960 to 1215	128	10	50	25	21	10	58	0.05	8	6
	1200 to 1400	300	10	50	25	19	10	50	0.05	8	6

7.3 Application circuit

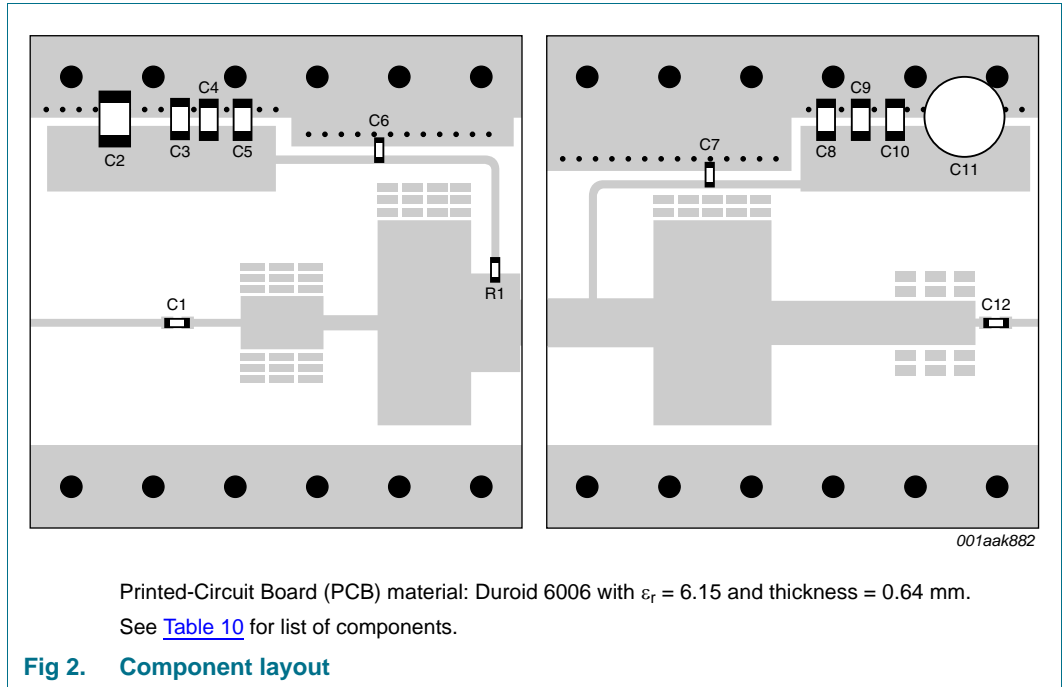

Table 10. List of components

See [Figure 2](#) for component layout.

Component	Description	Value	Remarks
C1, C6, C7, C12	multilayer ceramic chip capacitor	56 pF	[1]
C2	multilayer ceramic chip capacitor	10 μ F; 25 V	
C3, C4, C8, C9	multilayer ceramic chip capacitor	100 pF	[1]
C5, C10	multilayer ceramic chip capacitor	1 nF	[2]
C11	electrolytic capacitor	68 μ F; 63 V	
R1	SMD resistor	10 Ω	SMD 0603

[1] American Technical Ceramics type 100A or capacitor of same quality.

[2] American Technical Ceramics type 100B or capacitor of same quality.

8. Test information

8.1 Performance curves

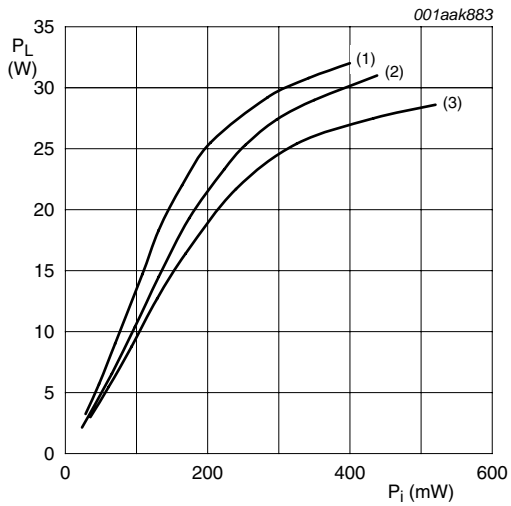

$V_{DS} = 50\text{ V}; I_{Dq} = 50\text{ mA}; t_p = 300\ \mu\text{s}; \delta = 10\%$.
 (1) $f = 1200\text{ MHz}$
 (2) $f = 1300\text{ MHz}$
 (3) $f = 1400\text{ MHz}$

Fig 3. Load power as a function of input power; typical values

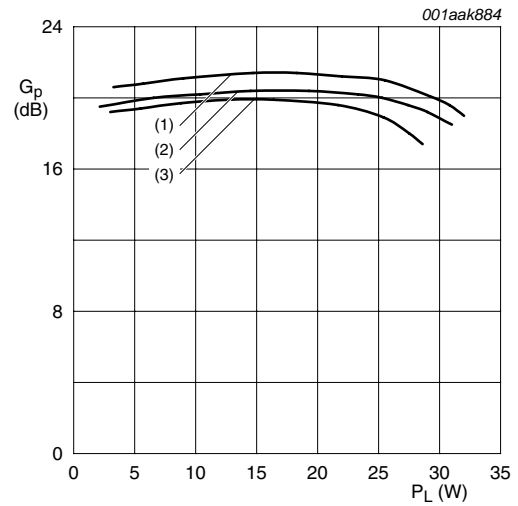

$V_{DS} = 50\text{ V}; I_{Dq} = 50\text{ mA}; t_p = 300\ \mu\text{s}; \delta = 10\%$.
 (1) $f = 1200\text{ MHz}$
 (2) $f = 1300\text{ MHz}$
 (3) $f = 1400\text{ MHz}$

Fig 4. Power gain as a function of load power; typical values

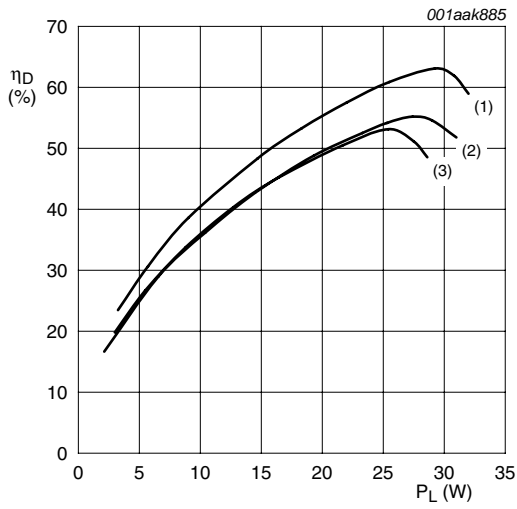

$V_{DS} = 50\text{ V}; I_{DQ} = 50\text{ mA}; t_p = 300\ \mu\text{s}; \delta = 10\%$.
 (1) $f = 1200\text{ MHz}$
 (2) $f = 1300\text{ MHz}$
 (3) $f = 1400\text{ MHz}$

Fig 5. Drain efficiency as a function of load power; typical values

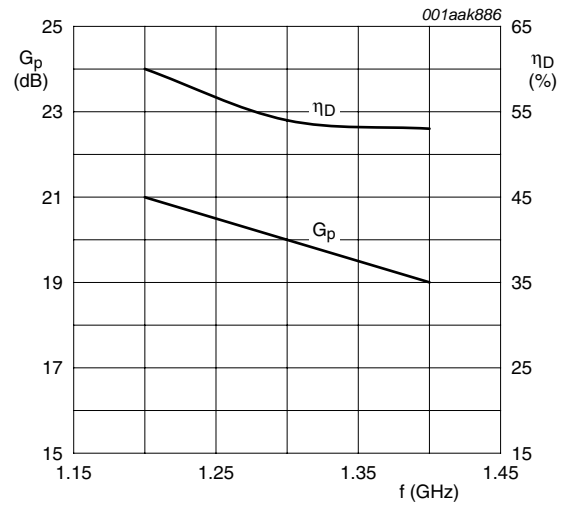

$V_{DS} = 50\text{ V}; I_{DQ} = 50\text{ mA}; t_p = 300\ \mu\text{s}; \delta = 10\%$.

Fig 6. Power gain and drain efficiency as function of frequency; typical values

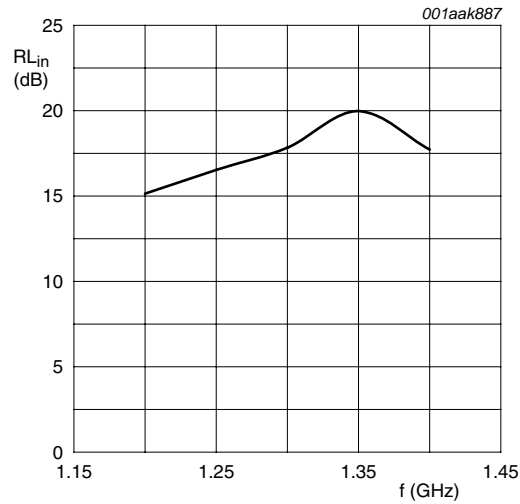

$P_L = 25\text{ W}; V_{DS} = 50\text{ V}; I_{DQ} = 50\text{ mA}; t_p = 300\ \mu\text{s}; \delta = 10\%$.

Fig 7. Input return loss as a function of frequency; typical values

9. Package outline

Flanged LDMOST ceramic package; 2 mounting holes; 2 leads

SOT467C

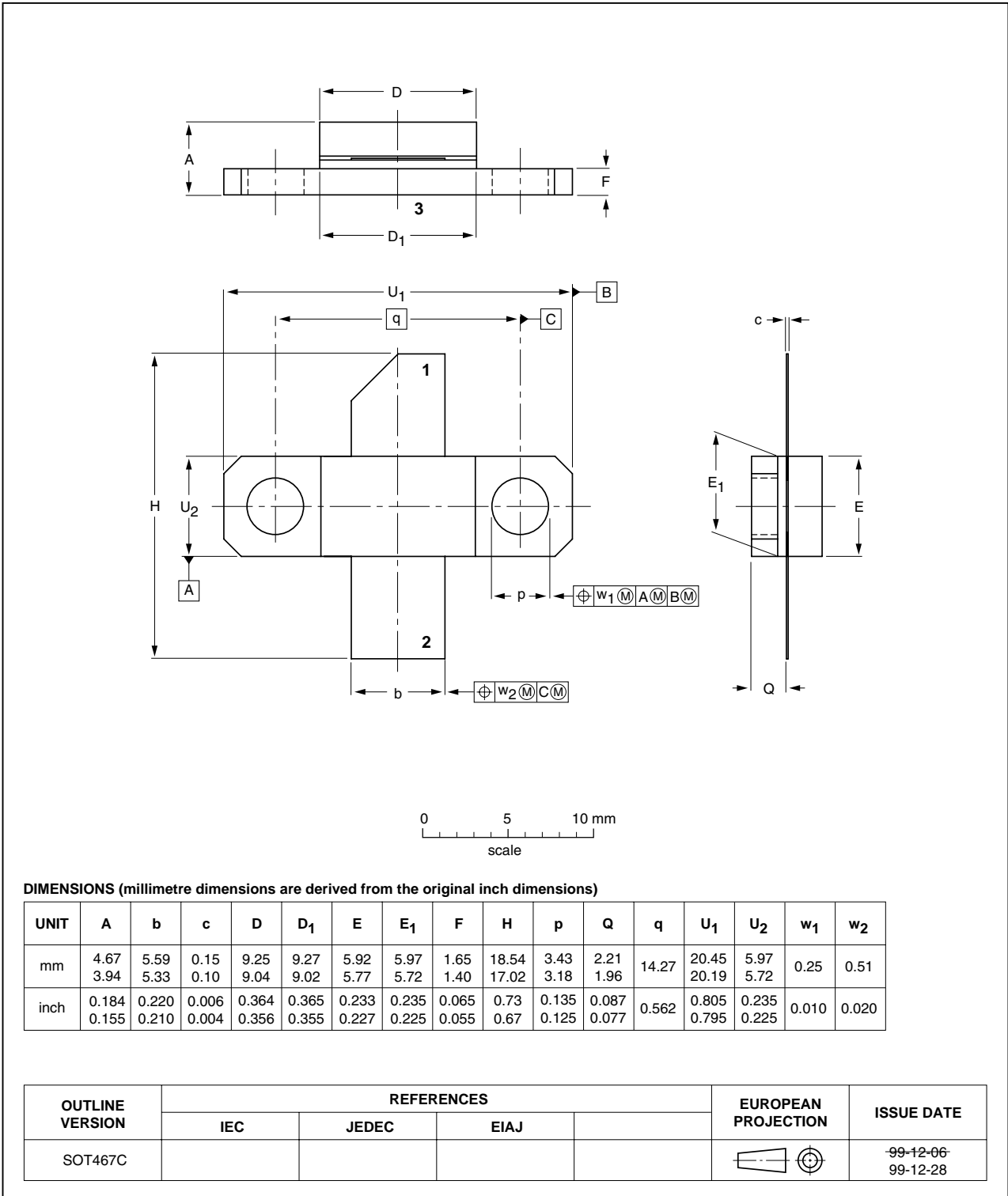

Fig 8. Package outline SOT467C

10. Abbreviations

Table 11. Abbreviations

Acronym	Description
LDMOS	Laterally Diffused Metal-Oxide Semiconductor
LDMOST	Laterally Diffused Metal-Oxide Semiconductor Transistor
RF	Radio Frequency
SMD	Surface Mounted Device
VSWR	Voltage Standing-Wave Ratio

11. Revision history

Table 12. Revision history

Document ID	Release date	Data sheet status	Change notice	Supersedes
BLL6H0514-25_4	20100330	Product data sheet	-	BLL6H0514-25_3
Modifications:	• Figure 3 on page 6 : the unit on the X-axis is corrected to mW.			
BLL6H0514-25_3	20100223	Product data sheet	-	BLL6H0514-25_2
BLL6H0514-25_2	20090317	Objective data sheet	-	BLL6H0514-25_1
BLL6H0514-25_1	20090305	Objective data sheet	-	-

12. Legal information

12.1 Data sheet status

Document status ^{[1][2]}	Product status ^[3]	Definition
Objective [short] data sheet	Development	This document contains data from the objective specification for product development.
Preliminary [short] data sheet	Qualification	This document contains data from the preliminary specification.
Product [short] data sheet	Production	This document contains the product specification.

[1] Please consult the most recently issued document before initiating or completing a design.

[2] The term 'short data sheet' is explained in section "Definitions".

[3] The product status of device(s) described in this document may have changed since this document was published and may differ in case of multiple devices. The latest product status information is available on the Internet at URL <http://www.nxp.com>.

12.2 Definitions

Draft — The document is a draft version only. The content is still under internal review and subject to formal approval, which may result in modifications or additions. NXP Semiconductors does not give any representations or warranties as to the accuracy or completeness of information included herein and shall have no liability for the consequences of use of such information.

Short data sheet — A short data sheet is an extract from a full data sheet with the same product type number(s) and title. A short data sheet is intended for quick reference only and should not be relied upon to contain detailed and full information. For detailed and full information see the relevant full data sheet, which is available on request via the local NXP Semiconductors sales office. In case of any inconsistency or conflict with the short data sheet, the full data sheet shall prevail.

Product specification — The information and data provided in a Product data sheet shall define the specification of the product as agreed between NXP Semiconductors and its customer, unless NXP Semiconductors and customer have explicitly agreed otherwise in writing. In no event however, shall an agreement be valid in which the NXP Semiconductors product is deemed to offer functions and qualities beyond those described in the Product data sheet.

12.3 Disclaimers

Limited warranty and liability — Information in this document is believed to be accurate and reliable. However, NXP Semiconductors does not give any representations or warranties, expressed or implied, as to the accuracy or completeness of such information and shall have no liability for the consequences of use of such information.

In no event shall NXP Semiconductors be liable for any indirect, incidental, punitive, special or consequential damages (including - without limitation - lost profits, lost savings, business interruption, costs related to the removal or replacement of any products or rework charges) whether or not such damages are based on tort (including negligence), warranty, breach of contract or any other legal theory.

Notwithstanding any damages that customer might incur for any reason whatsoever, NXP Semiconductors' aggregate and cumulative liability towards customer for the products described herein shall be limited in accordance with the *Terms and conditions of commercial sale* of NXP Semiconductors.

Right to make changes — NXP Semiconductors reserves the right to make changes to information published in this document, including without limitation specifications and product descriptions, at any time and without notice. This document supersedes and replaces all information supplied prior to the publication hereof.

Suitability for use — NXP Semiconductors products are not designed, authorized or warranted to be suitable for use in medical, military, aircraft, space or life support equipment, nor in applications where failure or

malfunction of an NXP Semiconductors product can reasonably be expected to result in personal injury, death or severe property or environmental damage. NXP Semiconductors accepts no liability for inclusion and/or use of NXP Semiconductors products in such equipment or applications and therefore such inclusion and/or use is at the customer's own risk.

Applications — Applications that are described herein for any of these products are for illustrative purposes only. NXP Semiconductors makes no representation or warranty that such applications will be suitable for the specified use without further testing or modification.

NXP Semiconductors does not accept any liability related to any default, damage, costs or problem which is based on a weakness or default in the customer application/use or the application/use of customer's third party customer(s) (hereinafter both referred to as "Application"). It is customer's sole responsibility to check whether the NXP Semiconductors product is suitable and fit for the Application planned. Customer has to do all necessary testing for the Application in order to avoid a default of the Application and the product. NXP Semiconductors does not accept any liability in this respect.

Limiting values — Stress above one or more limiting values (as defined in the Absolute Maximum Ratings System of IEC 60134) will cause permanent damage to the device. Limiting values are stress ratings only and (proper) operation of the device at these or any other conditions above those given in the Recommended operating conditions section (if present) or the Characteristics sections of this document is not warranted. Constant or repeated exposure to limiting values will permanently and irreversibly affect the quality and reliability of the device.

Terms and conditions of commercial sale — NXP Semiconductors products are sold subject to the general terms and conditions of commercial sale, as published at <http://www.nxp.com/profile/terms>, unless otherwise agreed in a valid written individual agreement. In case an individual agreement is concluded only the terms and conditions of the respective agreement shall apply. NXP Semiconductors hereby expressly objects to applying the customer's general terms and conditions with regard to the purchase of NXP Semiconductors products by customer.

No offer to sell or license — Nothing in this document may be interpreted or construed as an offer to sell products that is open for acceptance or the grant, conveyance or implication of any license under any copyrights, patents or other industrial or intellectual property rights.

Export control — This document as well as the item(s) described herein may be subject to export control regulations. Export might require a prior authorization from national authorities.

Non-automotive qualified products — Unless this data sheet expressly states that this specific NXP Semiconductors product is automotive qualified, the product is not suitable for automotive use. It is neither qualified nor tested in accordance with automotive testing or application requirements. NXP Semiconductors accepts no liability for inclusion and/or use of non-automotive qualified products in automotive equipment or applications.

In the event that customer uses the product for design-in and use in automotive applications to automotive specifications and standards, customer (a) shall use the product without NXP Semiconductors' warranty of the

product for such automotive applications, use and specifications, and (b) whenever customer uses the product for automotive applications beyond NXP Semiconductors' specifications such use shall be solely at customer's own risk, and (c) customer fully indemnifies NXP Semiconductors for any liability, damages or failed product claims resulting from customer design and use of the product for automotive applications beyond NXP Semiconductors' standard warranty and NXP Semiconductors' product specifications.

12.4 Trademarks

Notice: All referenced brands, product names, service names and trademarks are the property of their respective owners.

13. Contact information

For more information, please visit: <http://www.nxp.com>

For sales office addresses, please send an email to: salesaddresses@nxp.com

14. Contents

1 Product profile 1

1.1 General description 1

1.2 Features and benefits 1

1.3 Applications 1

2 Pinning information 2

3 Ordering information 2

4 Limiting values 2

5 Thermal characteristics 2

6 Characteristics 3

6.1 Ruggedness in class-AB operation 3

7 Application information 4

7.1 Impedance information 4

7.2 Typical data 4

7.3 Application circuit 5

8 Test information 6

8.1 Performance curves 6

9 Package outline 8

10 Abbreviations 9

11 Revision history 9

12 Legal information 10

12.1 Data sheet status 10

12.2 Definitions 10

12.3 Disclaimers 10

12.4 Trademarks 11

13 Contact information 11

14 Contents 12

Please be aware that important notices concerning this document and the product(s) described herein, have been included in section 'Legal information'.

© NXP B.V. 2010. All rights reserved.

For more information, please visit: <http://www.nxp.com>
 For sales office addresses, please send an email to: salesaddresses@nxp.com

Date of release: 30 March 2010
 Document identifier: BLL6H0514-25_4